

EXTRACTION ARMS



# PRX

The perfect extractor for  
harsh environments



**MOVEX**  
PURE ADVANTAGE



## **PRX – An effective “heavy duty” extraction arm**

The MOVEX PRX extraction arm is extremely easy-to-maneuver and offers positional stability, even when the arm is fully extended. The arm is equipped with a gas spring that balances the weight of the arm. The suction hood can be tilted 90° in all directions, and the wall mounting features a 360° swivel function. Supplied standard with flame-resistant PVC hose or neoprene high-temperature hose (PRX HD).



## External support joints for flexibility and other benefits

The external position of the link joint gives the option of tube and hose dimensions 5, 6 and 8". The joint design ensures optimum bending of the hose in terms of air throughput, which gives the PRX arm approximately 50% lower pressure drop than arms with internal link joint systems.

## Unique friction joint adjustment

The necessary adjustment of the friction joints is very easy. Unique to PRX is that no tools are required. The knob is easy to adjust and provides great flexibility in the required resistance. This makes PRX unique on the market today.

Equipped with knobs to adjust friction joints.

### **PRX unique on the market**

MOVEX always designs its local extractors with external support arms. This gives a low pressure drop and little risk of clogging. The smooth inside of the suction duct makes the extractor very easy-to-clean.



**MOVEX PRX** has 360° cast aluminum swivel.

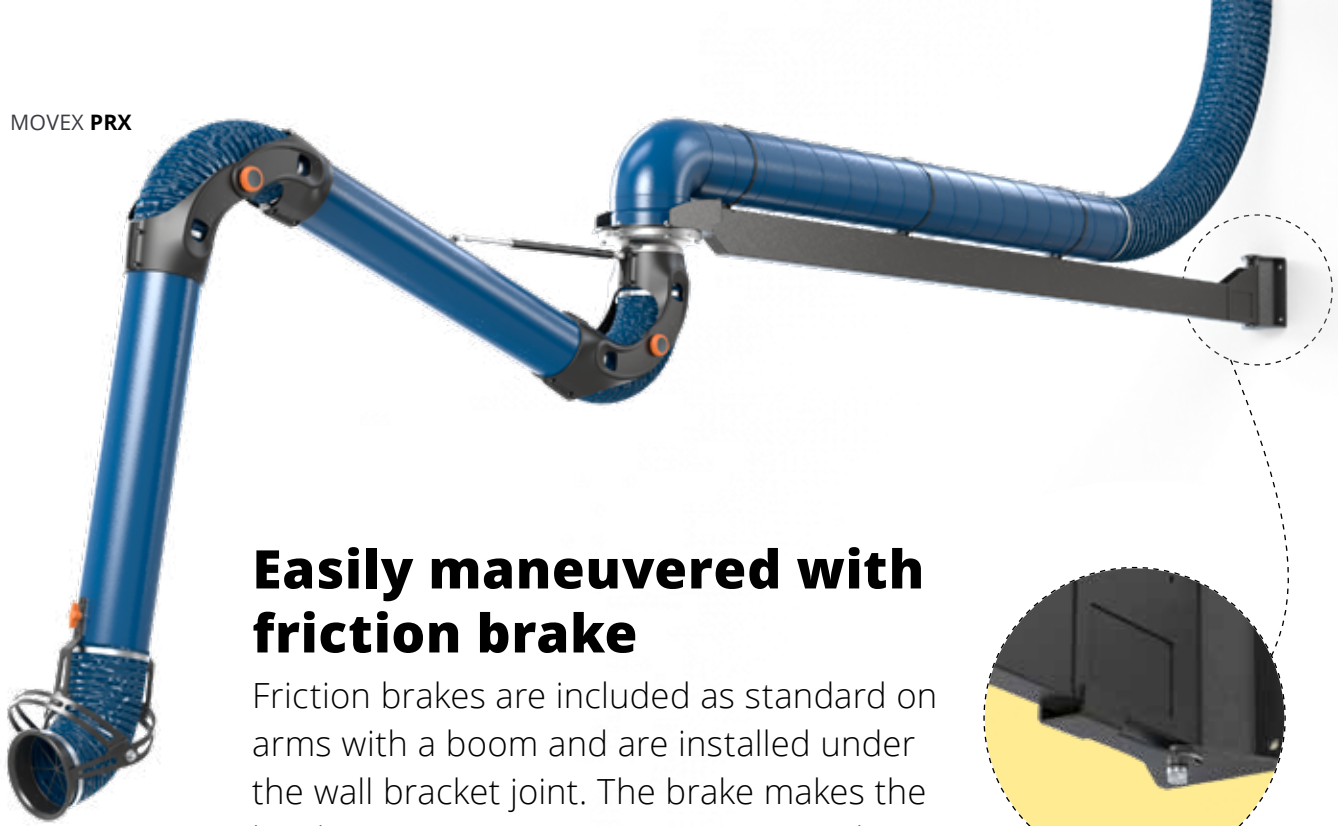

## Easily maneuvered with friction brake

Friction brakes are included as standard on arms with a boom and are installed under the wall bracket joint. The brake makes the local extractor easier to maneuver and ensures the boom retains its chosen position.

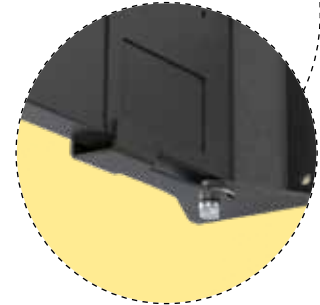

## A length to match your needs

PRX is available in lengths of 7/10/14/20/26/32 ft, and diameters of 5/6/8". For lengths of 20 to 32 ft, the arm is mounted on a boom with a 8" conduit – regardless of the local extractor diameter – for the lowest possible pressure drop.

## Hard-wearing suction hood

The suction nozzle delivers what MOVEX always promises – a tool for a working environment free from airborne pollutants. The suction hood is made entirely of metal with the Movex simple quick-coupling system.

## Ceiling and floor brackets

PRX is supplied with a wall bracket as standard, but can also be floor or ceiling-mounted.

### PTXA

- Ceiling and floor brackets
- Available in lengths of 20/40/60/80/83/87".
- Rotatable 360°.

### PTZ

- Ceiling and floor bracket for a boom.
- Available in lengths of 20/40/60/80/99".
- Rotatable 180°.

PTXA (PRX 2000/3000/4000)

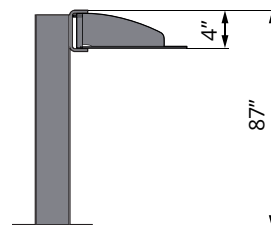
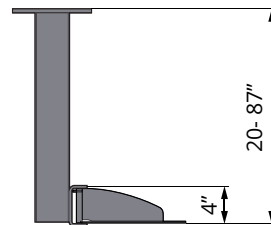

PTZ (PRX 6000)

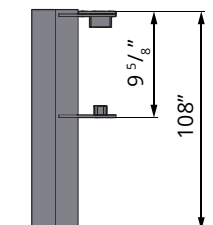
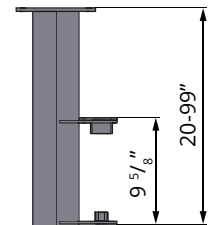

## Product design



### PRX **STANDARD**

- 360° swivel in cast aluminum.
- Brackets in dark gray powder-coated steel.
- Joints in anthracite PA & PP.
- Tubing in dark blue powder-coated aluminum.
- Hose in dark blue PVC-coated polyamide weave.
- Manual damper, step-adjustable.
- Suction nozzle, powder coated in anthracite gray finish.



### PRX **WHITE**

- 360° swivel in cast aluminum.
- Brackets in dark gray powder-coated steel.
- Joints in anthracite PA & PP.
- Pipes in white powder coated aluminium.
- Hose in white PVC.
- Manual damper, step-adjustable.
- Suction nozzle, powder coated in anthracite gray finish.



### PRX **HD**

- 360° swivel in cast aluminum.
- Brackets in dark gray powder-coated steel.
- Joints in anthracite PA & PP.
- Tubing in dark blue powder-coated aluminum.
- High-temperature hose in neoprene-coated fiberglass fabric.
- Manual damper, step-adjustable.
- Suction nozzle, powder coated in anthracite gray finish.

### **PRX HD – for high-stress jobs**

An extractor arm for more demanding jobs with higher temperatures than normal welding.

PRX HD has a flexible, wear-resistant, high-temperature hose in neoprene-coated fiberglass fabric able to withstand temperatures up to 275 °F.

### **Always choose a low pressure drop**

A low pressure drop always saves energy. A low pressure drop also produces less noise, reduces the risk of annoying ventilation sounds, and can more easily be combined with other exhaust products in the same system.

# Dimension drawing (in)

PRX 2000/3000/4000

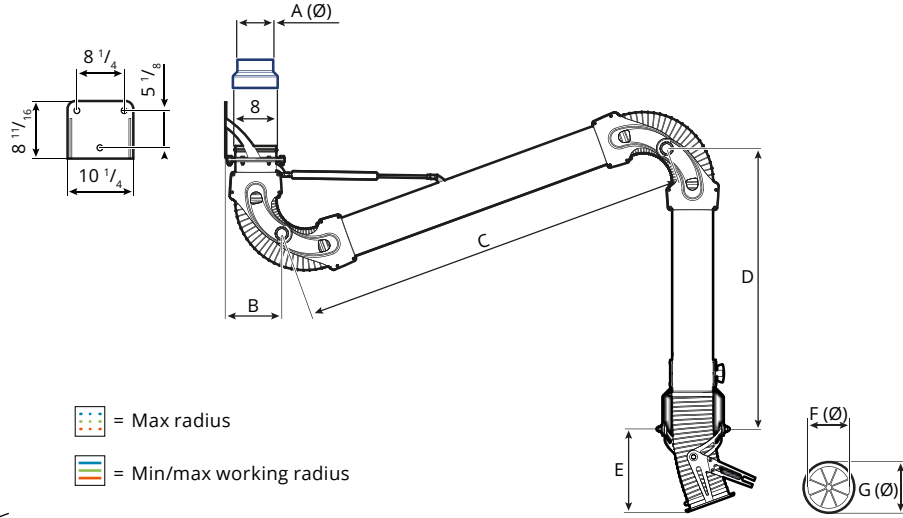

## Working radius

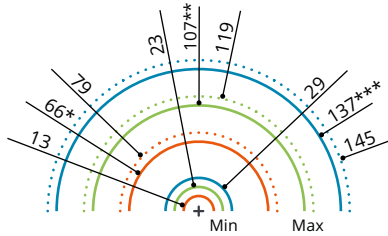

- = Max radius
- = Min/max working radius

\* For mounting height 87" and working height 30".  
 \*\* For mounting height 93" and working height 30".  
 \*\*\* For mounting height 99" and working height 30".

Model	A*	B*	C	D	E*	F*	G*
PRX 2000	6 5/16	9 1/2	33 7/8	24 1/16	10 13/16	6 5/16	7 1/2
PRX 3000	6 5/16	9 1/2	53 1/8	43 3/4	10 13/16	6 5/16	7 1/2
PRX 4000	6 5/16	9 1/2	68 7/8	57 1/2	10 13/16	6 5/16	7 1/2

\* Measurements specified in the table apply to PRX with hose dimension Ø6" and vary up to +/-2" for other dimensions.

# Pressure drop diagram

PRX Ø5"/Ø6"

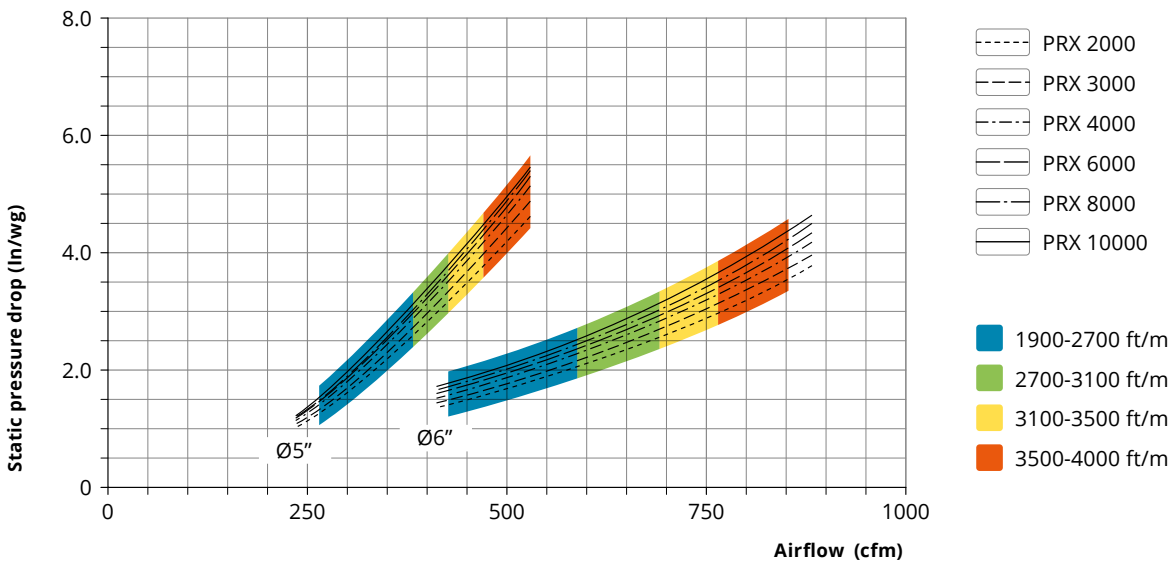

# Dimension drawing (in)

PRX 6000/8000/10000

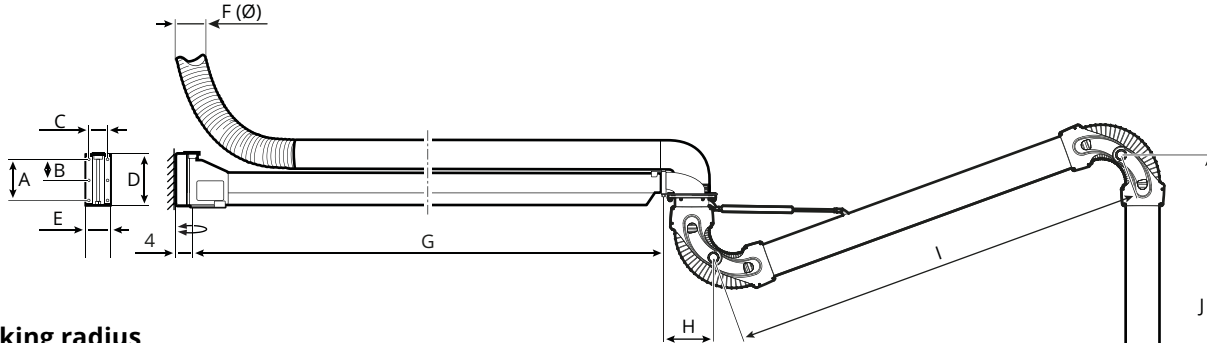

## Working radius

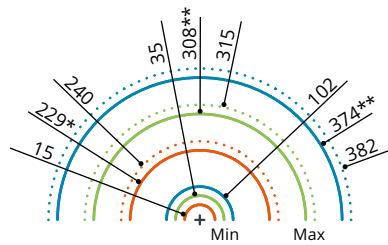

- = Max radius
- = Min/max working radius

\* For mounting height 93" and working height 30".  
 \*\* For mounting height 99" and working height 30".

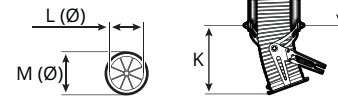

Model	A	B**	C	D	E	F	G	H*	I	J	K*	L*	M*
PRX 6000	6 13/16	-	4 5/16	9 1/2	5 7/8	7 7/8	116 1/8	9 15/16	53 1/8	43 3/4	10 13/16	6 5/16	7 1/2
PRX 8000	10 5/8	5 5/16	6 5/16	13 3/16	7 7/8	7 7/8	165 3/8	9 15/16	68 7/8	57 1/2	10 13/16	6 5/16	7 1/2
PRX 10000	10 5/8	5 5/16	6 5/16	13 3/16	7 7/8	7 7/8	233 1/16	9 15/16	68 7/8	57 1/2	10 13/16	6 5/16	7 1/2

\* Measurements specified in the table apply to PRX with hose dimension Ø6" and vary up to +/-2" for other dimensions.

\*\* Not applicable to PRX 6000.

# Pressure drop diagram

PRX Ø8"

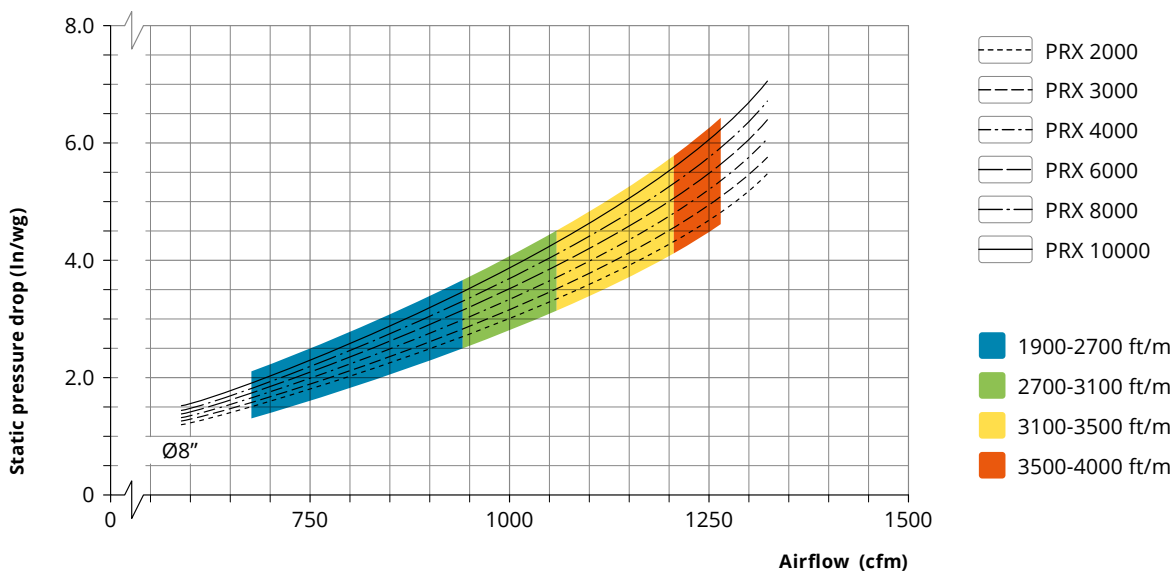

## Accessories

### Extension hose PFL

With magnetic nozzle and quick coupling in powder coated sheet steel.

#### Technical data - hose

Material PVC-coated polyamide fabric with fully embedded steel spring coil flame-protected according to DIN4102B2 (M2).  
Temperature range -22 °F to +212 °F

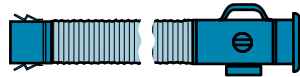

Item	Ø (in)	Length (ft)	Weight (lb)
PFL -125/4	Ø5	13	8
PFL -125/8	Ø5	26	13
PFL -160/4	Ø6	13	8
PFL -160/8	Ø6	26	13

### Conical hood PK

Hood with quick coupling. Aluminum, powder coated anthracite grey. Also available with LED lighting and/ or push button for fan control.

#### Technical data - LED (PK LED, PK LED/T)

Power 5 W at 350 mA  
Illuminance 2000 lx  
Color temperature 6500 K



Item	A (in)	B (in)	C (in)
PK-125	Ø4 <sup>13</sup> / <sub>16</sub>	Ø9 <sup>13</sup> / <sub>16</sub>	5 1/2
PK-160	Ø6 <sup>1</sup> / <sub>8</sub>	Ø11 <sup>13</sup> / <sub>16</sub>	5 1/2
PK-200	Ø7 <sup>13</sup> / <sub>16</sub>	Ø13 <sup>3</sup> / <sub>4</sub>	5 1/2

## Specification

### Form of delivery

The extractor arm is supplied partially unassembled including wall bracket, for simple installation.

### Surface treatment

Plastic parts PA, PA 30%  
Aluminum parts Anodized  
Steel parts Black oxide, zinc plated or powder coated

### Hose type PRX STANDARD/WHITE

PVC-coated polyamide fabric with fully embedded steel spring coil flame-protected according to DIN4102B2 (M2).  
Temperature-resistant between -22 °F to +212 °F.

### Hose type PRX HD

High-temperature hose in neoprene-coated fiberglass fabric. Temperature-resistant between -31 °F to +275 °F.

### Weight (lb)

Model	Ø5"	Ø6"	Ø8"
PRX 2000	26	32	33
PRX 3000	28	36	39
PRX 4000	30	37	43
PRX 6000	66	73	74
PRX 8000	114	120	124
PRX 10000	146	152	154

THE MOVEX RANGE INCLUDES EXTRACTION ARMS · VEHICLE EXHAUST EXTRACTION · FANS · FILTERS · CONTROLS

# MOVEX

104 Commerce Drive, NORTHAMPTON, PA 18067, USA • Tel: 610-440-0478 • Fax: 610-440-0480 • Email: info@movexinc.com

www.movexinc.com